

AARON MANUFACTURING INC.

HAND SINK ACCESSORIES

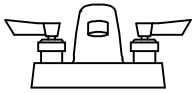

STANDARD FAUCET
ITEM NO. UBAF-01

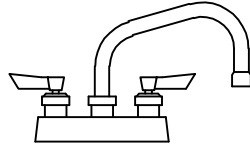

STANDARD SWING SPOUT
ITEM NO. UBIF-02

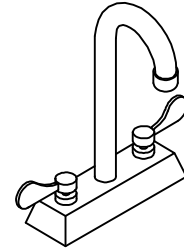

6" GOOSENECK SWING SPOUT
ITEM NO. UBAF-03

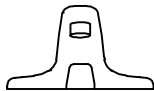

ELECTRONIC EYE FAUCET
ITEM NO. UBAF-04

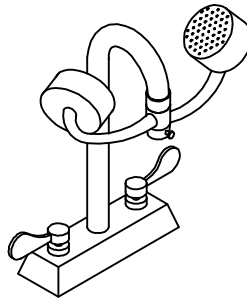

EYE WASH SPRAY ATTACHMENT
ITEM NO. UBIF-07

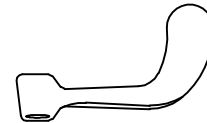

4" WRIST BLADE HANDLES (HANDICAP)
ITEM NO. UBAF-08

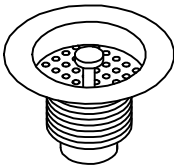

2" WASTE WITH STRAINER BASKET (3-1/2" HOLE)
ITEM NO. UBAW-03

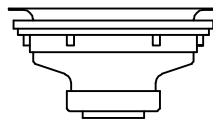

2" WASTE
ITEM NO. UBAW-01

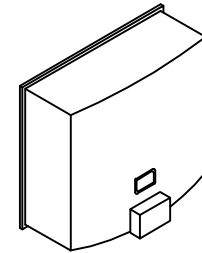

SOAP DISPENSER
ITEM NO. UBA-06

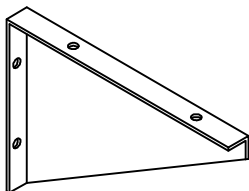

KNIFE BRACKET
ITEM NO. UBA-30

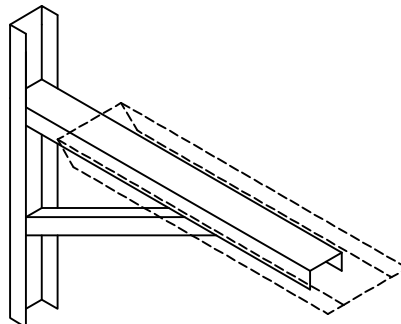

CANTILEVER BRACKET
ITEM NO. UBA-32

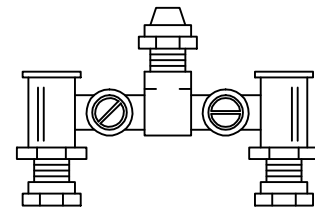

MIXING VALVE
ITEM NO. UBA-38

AARON MANUFACTURING INC.